



®

CORPORATION

FLAME ARRESTER

MODEL 77E-AF



MODEL 77E-AF

The Groth Model 77E-AF is designed to inhibit flame propagation in gas piping systems and to protect low pressure tanks containing flammable liquids. Arresters protect low flash point liquids from external sources of ignition providing increased fire protection and safety.

Technical Details

- Connection Sizes: 2" through 12" 150# ASME, DIN PN10, and PN16 Flanged Connection
- Housing standard material: Carbon Steel, Stainless Steel
- Bases standard material: Carbon Steel, Stainless Steel
- Flame element standard material: 316 Stainless Steel
- Operational Temperature Range: -4 to 140 °F (-20 to 60 °C)
- For Gases with MESH ≥ 0.65 mm (See figure below for IEC and NEC Gas Groupings)
- Maximum Operational Pressure: 1.15 bara (16.67 psia) or better, see charts and IOM
- Certified to ATEX Directive in compliance with EN ISO 16852:2016
- Thermocouple is required for flame detection per the ATEX code

Features

- Flame arrester utilizes multiple-element technology, in order to maximize flame quenching capability while minimizing pressure drop
- Removable element housing for ease of maintenance
- Spiral-wound, crimped ribbon flame elements
- Flame elements made standard with premium 316SS material, reducing corrosion
- Bi-directional with respect to flow and ignition source

Options

- Exterior painting or coating available
- Drains and instrumentation ports available
- Available factory installed thermocouples for flame sensing

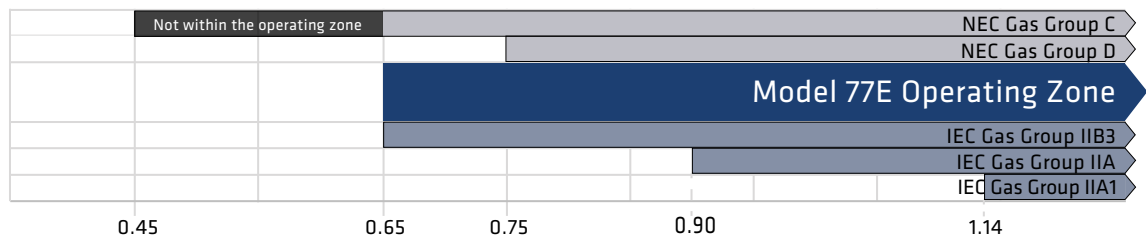

The NEC and IEC are the two recognized standards for gas groupings. The NEC is used in the United States while the IEC is international in scope and widely used in Europe. Both the NEC and IEC classify gases into explosion groups based on their maximum experimental safety gap ("MESG"). Customer is responsible for ensuring product selection based on MESG.

SPECIFICATIONS

Flange Connection Size In (mm)	Housing Nominal Size In (mm)	A Width In (mm)	B Height ± 1.0" In (mm)	Approx Ship. Weight Carbon Steel Lbs. (kg)
2 (50)	5 (125)	8.3 (211)	12.5 (318)	50 (23)
3 (80)	6 (150)	9.6 (244)	14.5 (368)	70 (32)
4 (100)	8 (200)	11.8 (300)	14.5 (368)	101 (46)
6 (150)	12 (300)	16.2 (411)	17.5 (445)	205 (93)
8 (200)	16 (400)	20.4 (518)	18.0 (457)	385 (175)
10 (250)	20 (500)	24.8 (630)	20.0 (508)	612 (278)
12 (300)	24 (600)	28.4 (721)	22.0 (559)	934 (424)

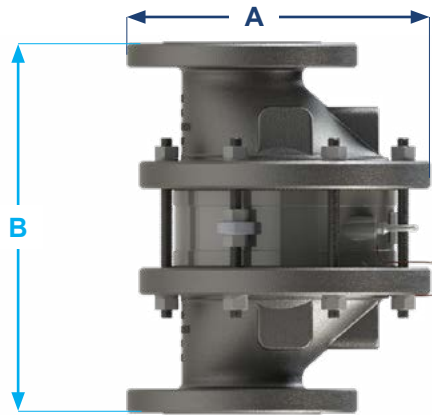

ATEX Straight Pipe Configuration:

Connection Size x Housing Size	Maximum Operational Pressure psia (bara)	Gas Group	End Condition	Maximum Pipe Length from Ignition Source to Flame Arrester	Allowable Bend(s)*	Maximum Burn Time at Atmospheric Pressure	Operational Temperature Range °F (°C)
2" x 5" thru 6" x 12"	18.85 (1.30)	IIB3 [MESG ≥ 0.65mm]	Closed or Open End	50 pipe diameters	None	Short-time burn rating (1 minute)	-4 to 140 (-20 to 60)
8" x 16" thru 12" x 24"	16.67 (1.15)						

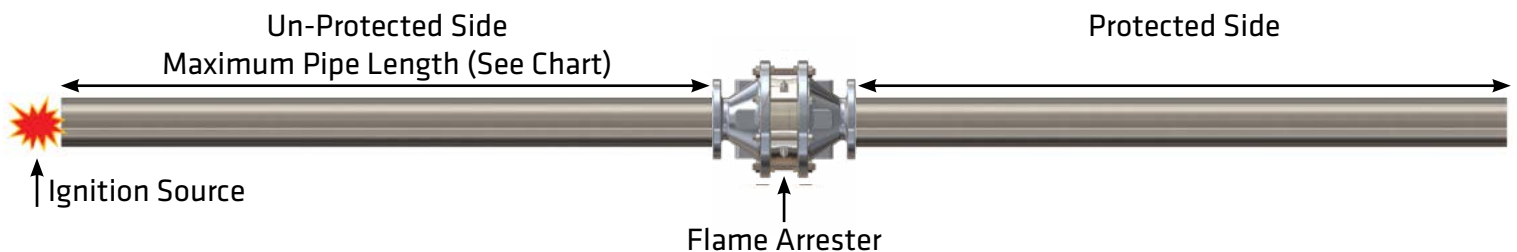

For an arrester to be properly applied, all the requirements for the following configuration scenario must be met. Model 77E-AF, ATEX Straight Pipe Configuration, is designed and type-tested according to EN ISO 16852:2016

FLOW CAPACITY

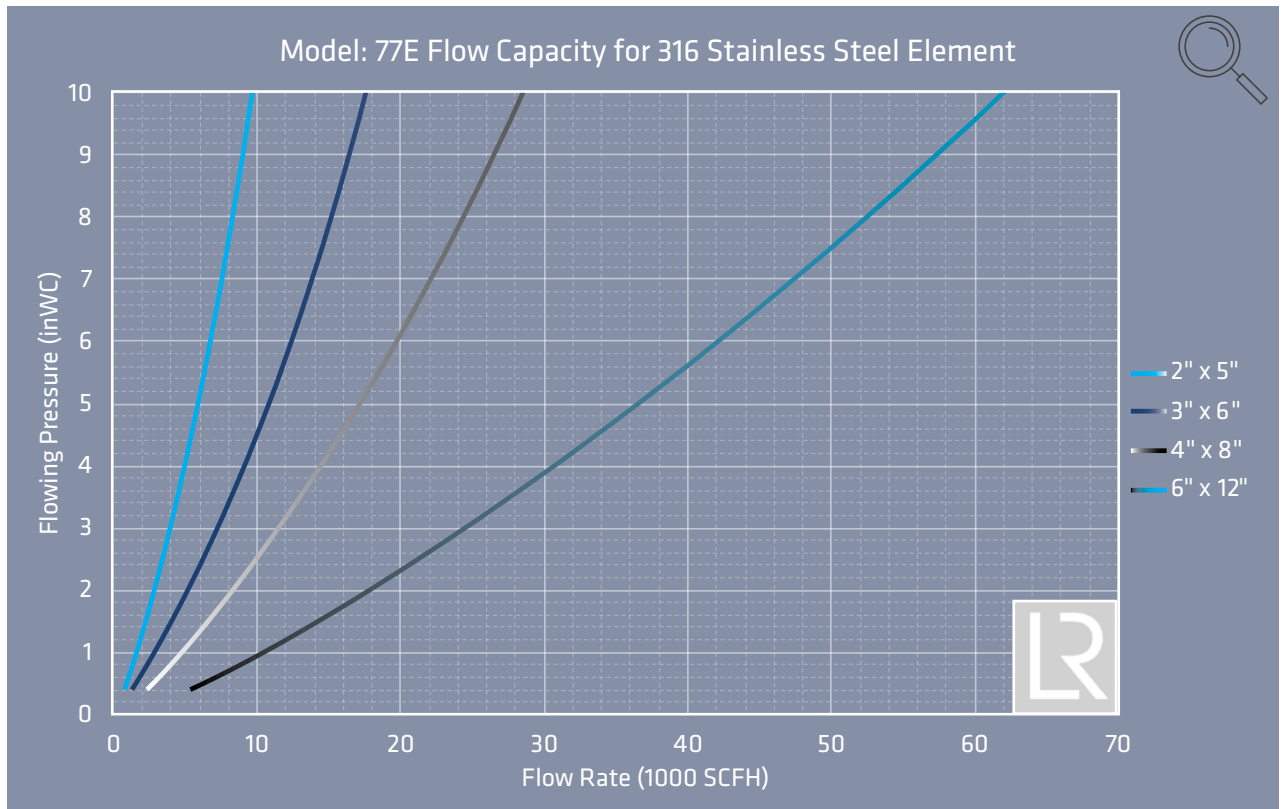
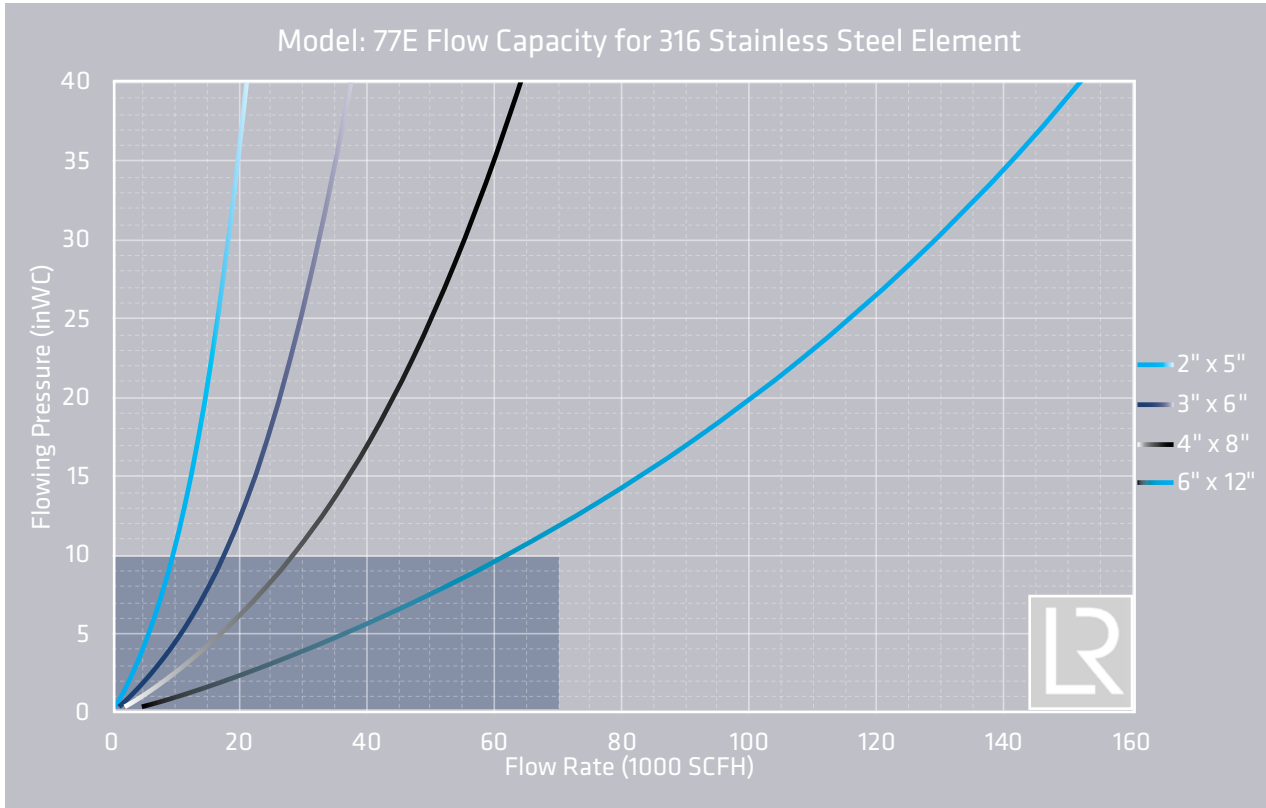

- The test equipment, procedures, and reporting methods utilized by Groth Corporation are based upon the standards API 2000/ISO 28300 and ISO 16852
- Flow data is for in-line mounting and does not include entrance or exit losses
- The Flow values based on air at 60° F venting to atmospheric pressure of 14.6959 psia
- Testing and verified by Llyod's Register Quality Assurance, Inc. in Houston, TX

FLOW CAPACITY

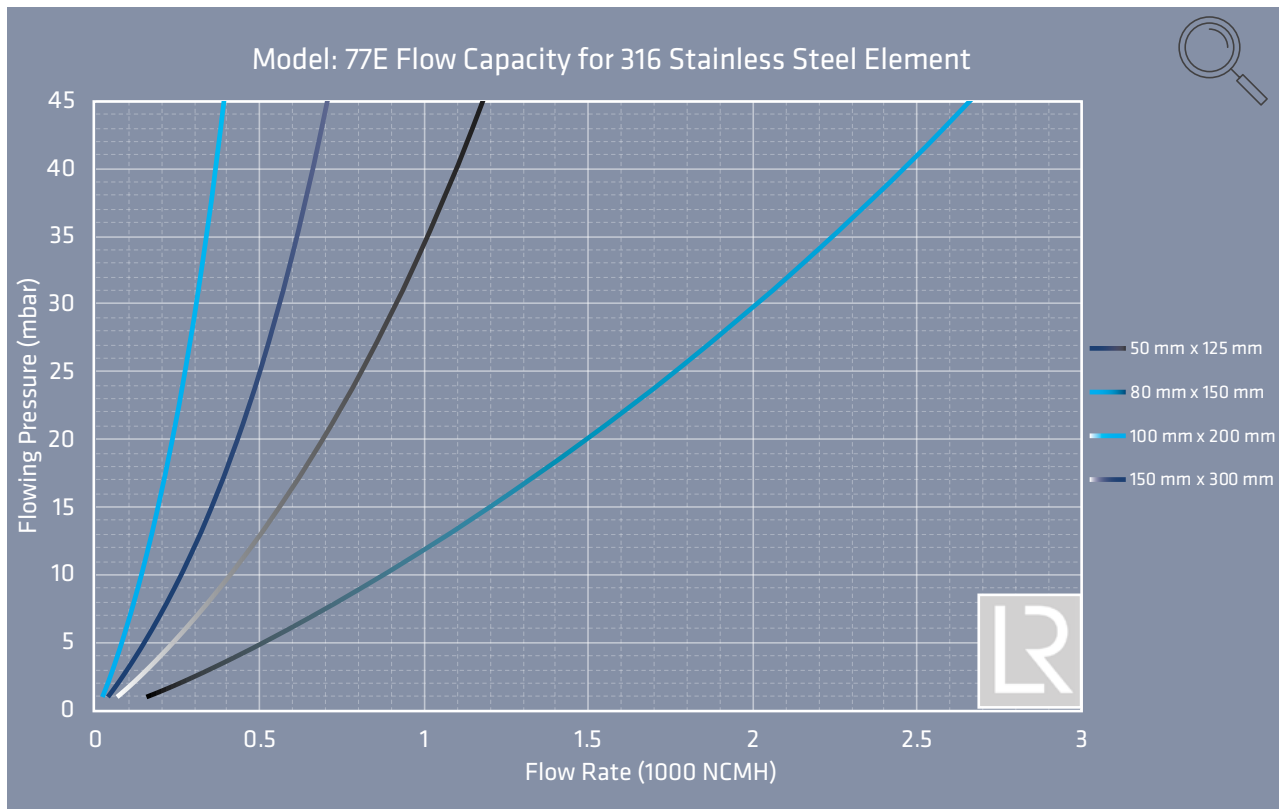
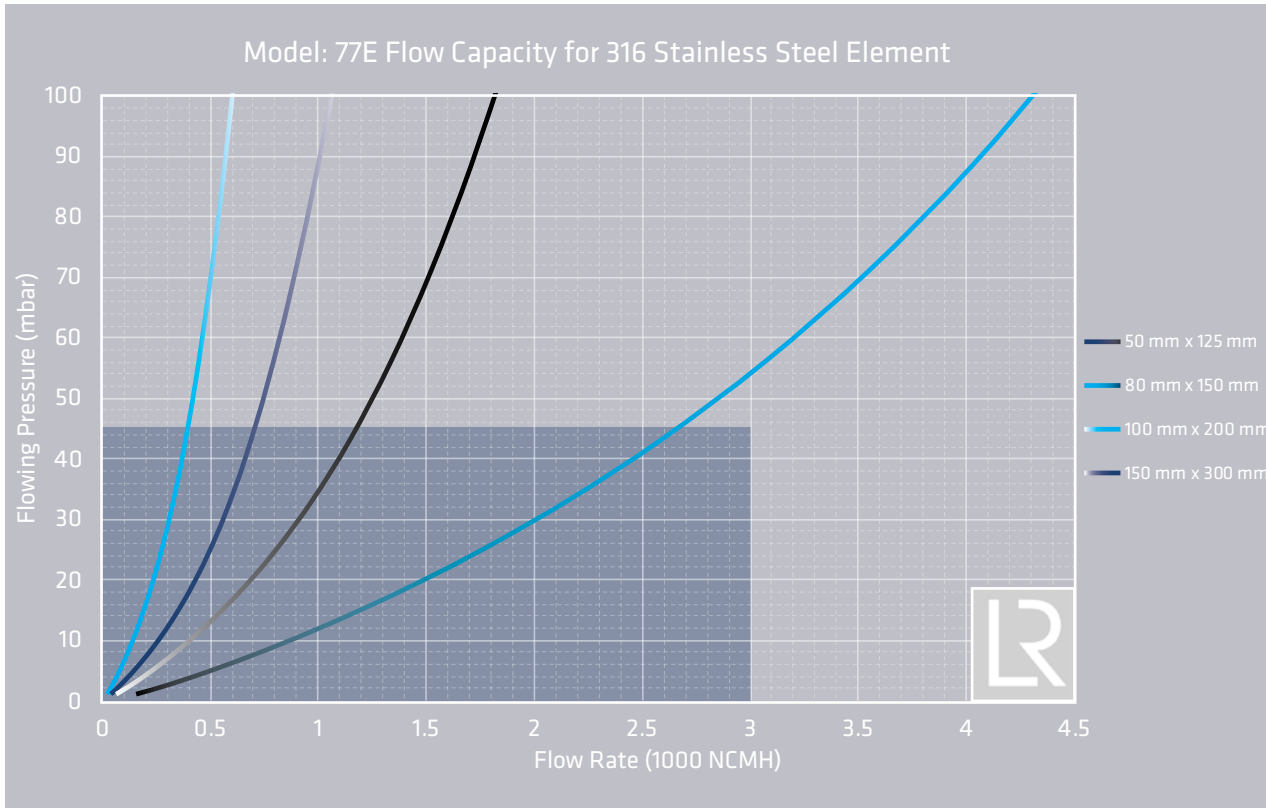

- The test equipment, procedures, and reporting methods utilized by Groth Corporation are based upon the standards API 2000/ISO 28300 and ISO 16852
- Flow data is for in-line mounting and does not include entrance or exit losses
- The Flow values based on air at 60° F venting to atmospheric pressure of 14.6959 psia
- Testing and verified by Llyod's Register Quality Assurance, Inc. in Houston, TX

FLOW CAPACITY

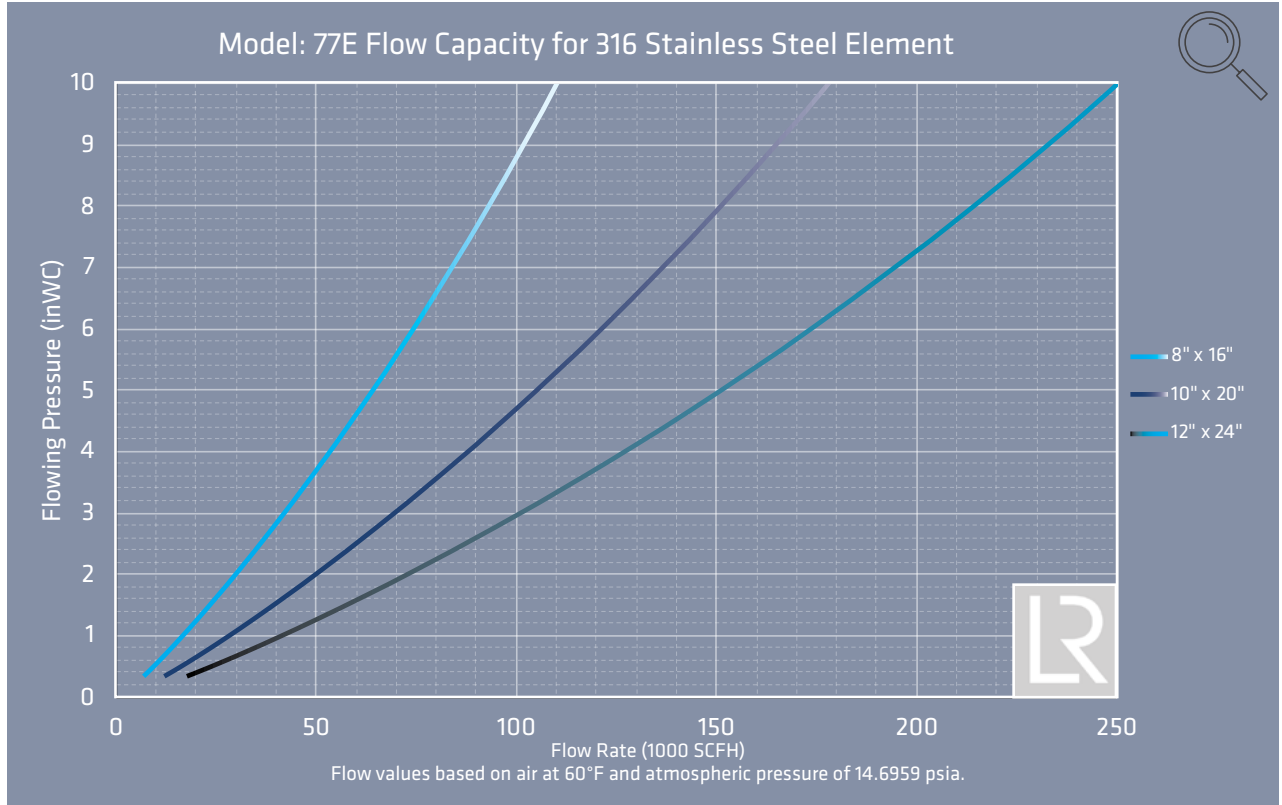
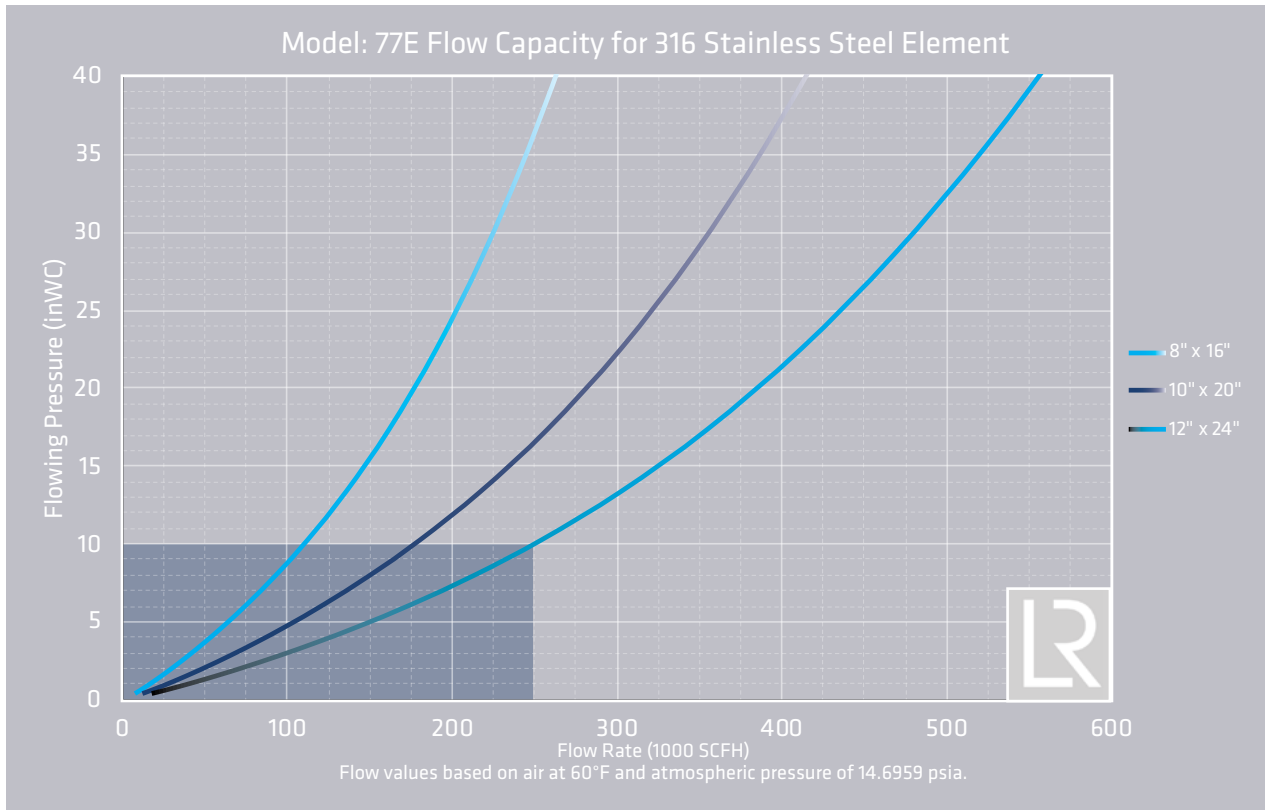

- The test equipment, procedures, and reporting methods utilized by Groth Corporation are based upon the standards API 2000/ISO 28300 and ISO 16852
- Flow data is for in-line mounting and does not include entrance or exit losses
- The Flow values based on air at 60° F venting to atmospheric pressure of 14.6959 psia
- Testing and verified by Llyod's Register Quality Assurance, Inc. in Houston, TX

FLOW CAPACITY

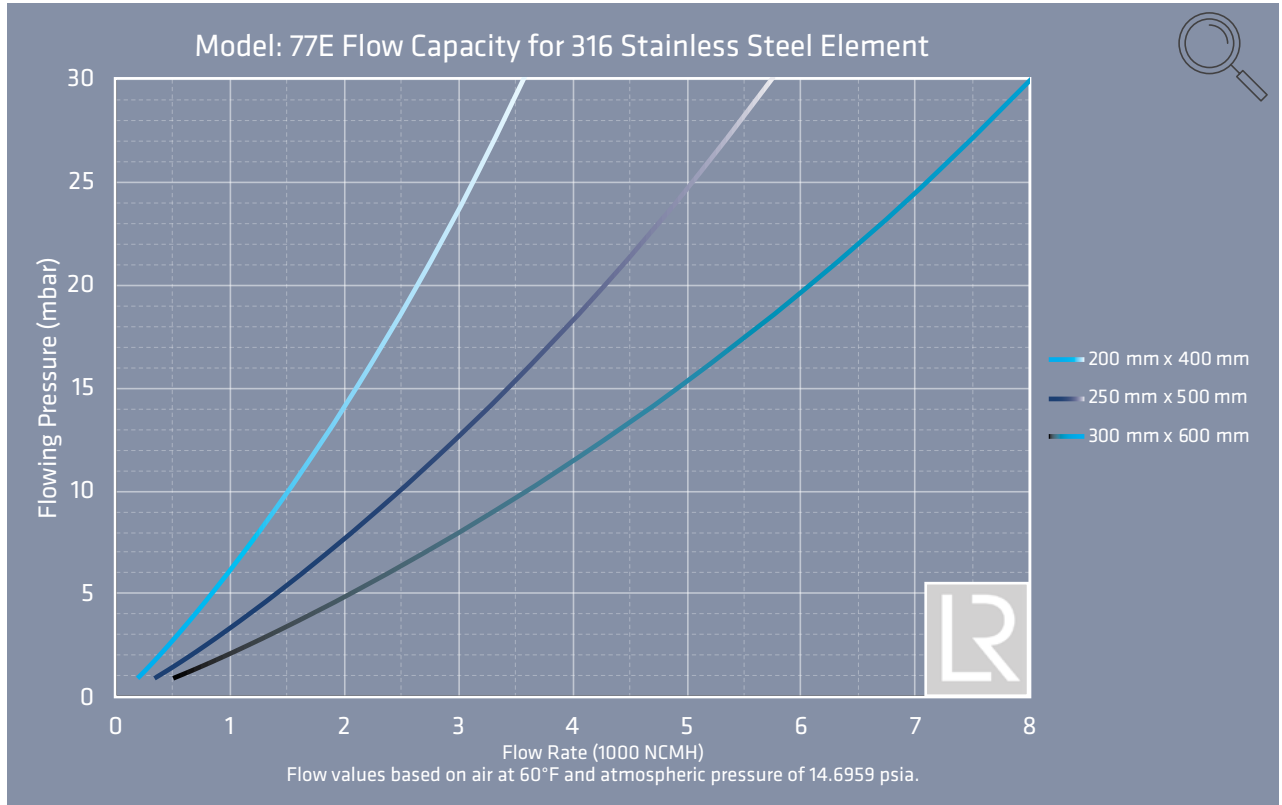
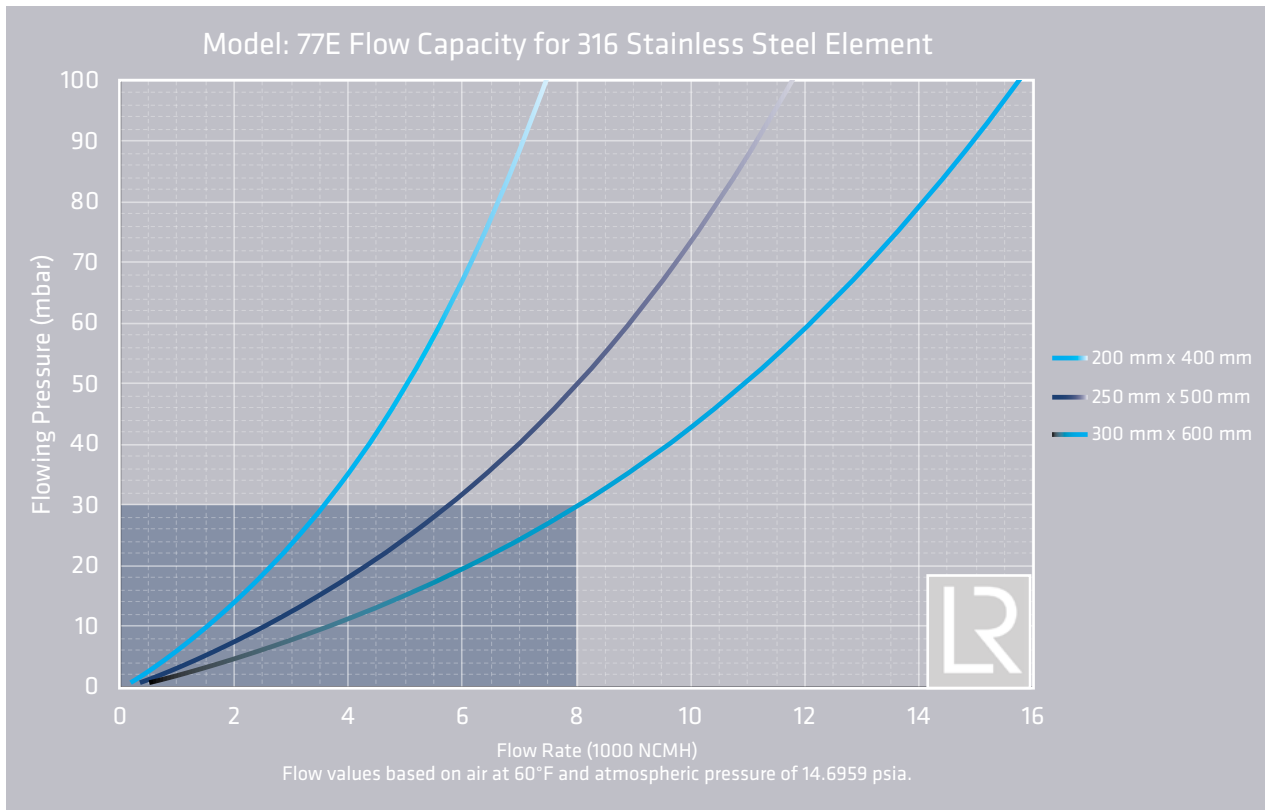

- The test equipment, procedures, and reporting methods utilized by Groth Corporation are based upon the standards API 2000/ISO 28300 and ISO 16852
- Flow data is for in-line mounting and does not include entrance or exit losses
- The Flow values based on air at 60° F venting to atmospheric pressure of 14.6959 psia
- Testing and verified by Llyod's Register Quality Assurance, Inc. in Houston, TX

HOW TO ORDER

For easy ordering, select proper model numbers

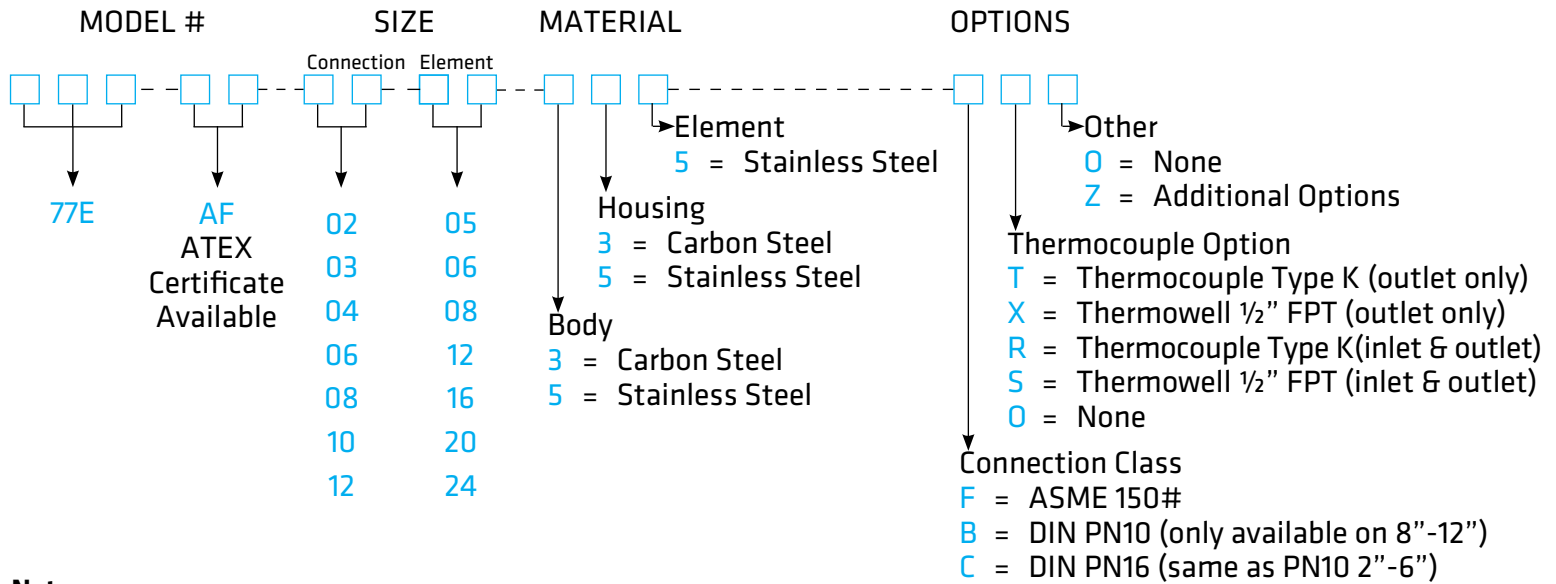

Notes

- Include model number when ordering
- For special options, consult factory

Example

7 7 E - A F - 0 2 0 5 - 3 3 5 - F T 0

Indicates a 2" x 5" Model 77E-AF, ATEX Certificate Available, with carbon steel bases, carbon steel housing, 316SS element, 150# ASME bolted inlet/outlet, a thermocouple Type K on the outlet and no other options.



GROTHCORP.COM